



The HMT25 geared multi-turn encoder provides absolute position information over multiple turns of the input shaft. It keeps track of the exact position even during periods of power loss without the need for a battery backup. The HMT25 series is capable of outputs up to 4096 counts per turn and can count up to 4096 turns — a total of 24 bits or 16,777,216 positions. Units are enclosed in a 2.5-inch diameter sealed package to withstand rugged environments and they carry an IP 66 environmental rating. These encoders meet the long travel and high resolution requirements of robotics, rolling mills, rotary tables, cable winding, printing, converting and material handling systems.

Mechanical Specifications

- Shaft Diameter:** 0.375" (0.5" optional)
- Flat on Shaft:** 0.80" long x 0.030" deep
- Shaft Loading:** 40 lbs axial, 36 lbs radial (90 lbs axial and 80 lbs radial with 0.5" shaft)
- Shaft Runout:** 0.0005 TIR at midpoint of shaft
- Starting Torque at 25°C:** 2.5 in-oz (max)
- Bearings:** Dual, preloaded, Class ABEC 7
- Shaft Material:** 416 stainless steel
- Bearing Housing:** Die cast aluminum with iridite finish
- Cover:** Die cast aluminum
- Bearing Life:** 1×10^{10} at 10% rated load
- Maximum RPM:** 6,000 (see Frequency Response, below)
- Moment of Inertia:** 4.3×10^{-4} oz-in-sec²
- Weight:** 16 oz nominal

Electrical Specifications

- Code:** Natural binary, gray code or SSI compatible
- Counts per Shaft Turn:** 4096, 12 bits
- Number of Turns:** up to 4096, 12 bits
- Supply Voltage:** 5 - 28 VDC
- Current Requirements:** 130 mA typical
- Output:** Line driver or open collector
- Frequency Response:** 100 kHz
- Protection Level:** Overvoltage, reverse voltage. Outputs short-circuit protected (1 minute max)
- Output Termination Pinouts:** See Tables, next page

Environmental Specifications

- Enclosure Rating:** IP66
- Temperature:** Operating, 0° to 70° C; Extended, -40° to +85° C; Storage, -20° to 90° C (to -40° if extended range is called out)
- Shock:** 50 g's 11 msec
- Vibration:** 5 to 2000 Hz @ 20 g's (see special note next page)
- Humidity:** 98% Non-condensing

HMT25 Multi-Turn Encoder Ordering Options FOR ASSISTANCE CALL 800-350-2727

Use this diagram, working from left to right to construct your model number (example: HMT25D-SS-12X12GC-28V/V-CW-SM18/32). All notes and tables referred to can be found on pages 50-51.

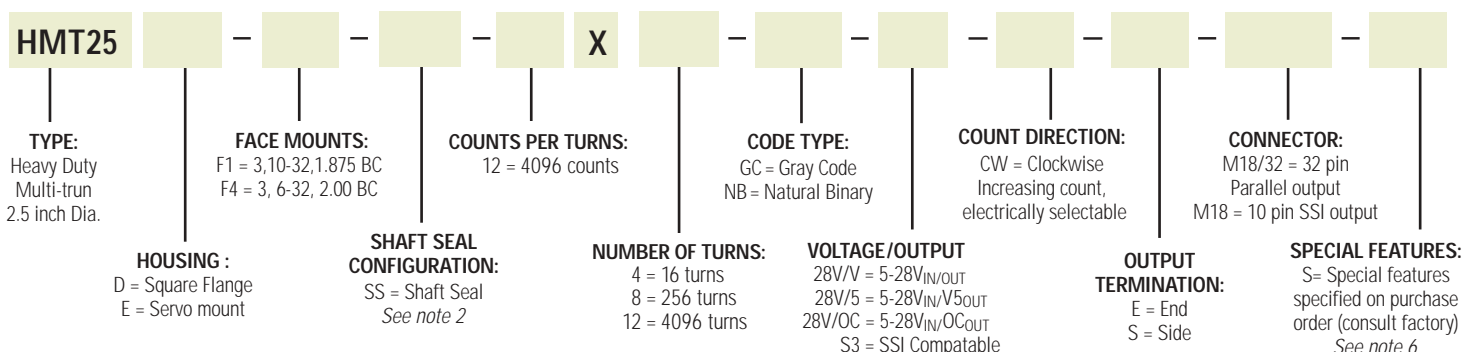

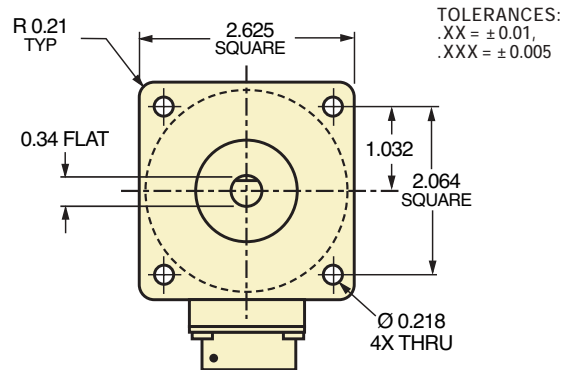
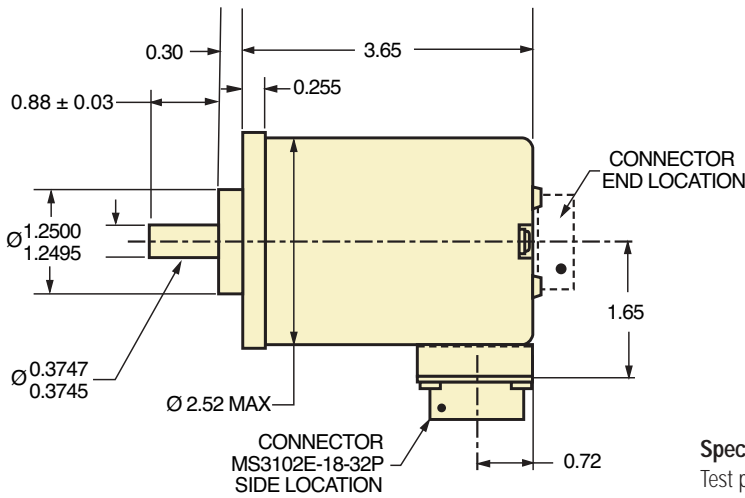

Special note on vibration testing:
 Test profile is 0.3 g's ramp to 20 g's from 5 to 40 Hz and 20 g's from 40 Hz to 2000 Hz.

HMT25 Output Terminations for Parallel Output ¹			
PIN	FUNCTION (2)	PIN	FUNCTION (2)
A	T11 (MSB)	T	F7
B	T10	U	F6
C	T9	V	F5
D	T8	W	F4
E	T7	X	F3
F	T6	Y	F2
G	T5	Z	F1
H	T4	a	F0 (LSB)
J	T3	b	N/C
K	T2	c	LATCH
L	T1	d	DIR CONTROL
M	T0 (LSB)	e	ENABLE (Option)
N	F11 (MSB)	f	N/C
P	F10	g	0 V
R	F9	h	+V
S	F8	j	CASE GND

(1) Parallel output uses a MS3112E18-32P, 32 Pin connector on the encoder body
 (2) TXX = Turns counts, FXX = Fine resolution counts

Direction Control: The HMT25 comes standard with a Direction Control bit. Normal operation is CW increasing count when viewed from the shaft end. This pin is normally pulled HI internally. To reverse the count direction, this pin must be pulled LO (Circuit Common). Optionally this can be designated as CCW increasing count when HI, in which case LO will be CW increasing count.

Latch: Outputs are active and provide continuous information when this pin is HI. When this pin is pulled LO (Circuit Common) the outputs are latched at the logic state that is present when the latch is applied and will stay latched until this pin is no longer LO. This pin is pulled HI internally.

Enable (optional): This option allows the operator to momentarily deactivate the outputs from the encoder. This may be useful in instances where the outputs from several different encoders must be sampled independently. Output is active when this pin is HI. When pulled LO (Circuit Common) all outputs go to high impedance state (Tri-state) and are inactive until the LO state is removed. This pin is pulled HI internally. To order this option on the HMT25 make sure the model number has -S on the end, followed by the description, -S = output enable.

HMT25 Output Terminations for Optional 24 Bit SSI Output				
FUNCTION	CABLE	CONNECTOR*	TERM BOARD (H38 & H40 ONLY)	
			H38	H40
DATA+	YEL	A	4	1
DATA-	WHT/YEL	H	7	7
CLOCK+	BLU	B	5	2
CLOCK-	WHT/BLU	I	8	8
DIRECTION CONTROL	ORN	C	6	3
ENABLE (Optional)	VIOLET	E	9	—
RESET (Optional)	WHT/ORN	J	10	9
+V (SUPPLY VOLTAGE)	RED	D	3	4
0 V (CIRCUIT COMMON)	BLK	F	2	5
CASE GROUND	GRN	G	1	6

*Connector is an MS3102E18-1P, 10-pin connector on the encoder body and mates to an MS3106F18-1S connector or can be used with a standard cable/ connector assembly, BEI part 924-31186-18XX. (Where XX = 10, 20, or 30 for a 10, 20 or 30 foot cable length.)

RESET (Optional): The Reset pin (Pin J) is normally HI and is pulled up internally to the positive supply voltage. To activate the Reset function, Pin J must be pulled LO by connecting it to signal common for 1 second or greater. This causes the present encoder position to be stored into non-volatile memory as an offset value and the output of the encoder is then set to the value of "0". The encoder will retain this offset even if the power is turned off and on again. A new "0" position can be set by rotating the encoder shaft to a new position and then activating the Reset pin again. To order this option for the HMT25, make sure the model number has -S on the end followed by the description, -S = Reset.

24Bit, SSI Compatible Output Timing

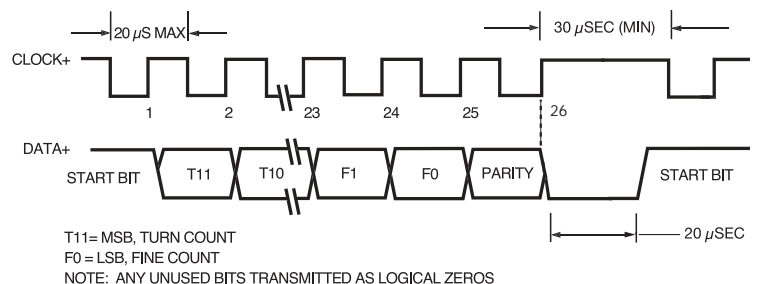

Parallel Absolute Output

The two most common types of absolute outputs are the Gray Code and the Natural Binary. Resolution for absolute encoders is expressed in "bits" where each successive bit increases the resolution by a factor of two. For example, 10 bits = $2^{10} = 1024$ counts per revolution.

Natural binary code (Figure 1) is constructed so that the code counts up using the natural sequence of binary counting, i.e. 000, 001, 010, 011, 100 . . etc. The drawback to using this code sequence is that at several count positions the code will have transitions on multiple bits simultaneously. Due to the normal variations caused by gate delays, line impedances, etc. the actual transitions will not occur simultaneously. Reading data during one of these times could result in an erroneous reading. This can be overcome by taking multiple readings.

Gray code (Figure 2), by contrast, is designed to avoid the multiple transition problem entirely. It is specifically constructed so that only one bit will transition at a time. This ensures that state changes are much less ambiguous to the controller and is generally considered to be a more robust type of absolute code.

Regardless of the code type, one of the characteristics of absolute encoders is that they can readily be used for any resolution up to and including their maximum resolution. For example, a 12 bit encoder can be used at only 8 bits by ignoring (or disconnecting) the four lowest significant bits (LSB). This enables an installation that uses multiple absolute encoders to use the same encoder throughout with each controller using only the bits that it needs.

Figure 1 Natural Binary

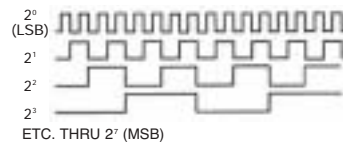
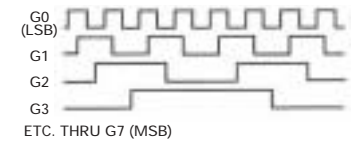

Figure 2 Gray Code



Ordering 8-Bit Absolutes

For years, we produced encoders with a maximum resolution of 8 bits. Lots of those old 8 bit encoders are still around. We update them to newer 12 bit designs on a case-by-case basis. If you have an 8 bit encoder, here is how that model number was constructed: **Direction of Rotation, Count, Code** and **Latch** designators were inserted between **Shaft Seal Configuration** and **Output IC** as shown below. To specify an equivalent encoder based on the 12 bit design, please call our Applications Specialists at **800-ENCODER** (800-362-6337) or check our web site at www.beiied.com.

Direction of Rotation: CCW or CW

Count: 8

Code: GC= Gray Code or NB= Natural Binary

Latch: L= Latch or Blank=None

Output Terminations: EM20=MS3102R20-29P or ED25=DB25P; SM18 = MS3102R18-1P; C18 = Cable, with length specified in inches. Specify ED25 for Line Driver Outputs.

Example: H25E-F1-SS-CCW-8GC-7406R-EM20
(one possible encoder configuration with the 8-Bit Absolute Option.)

Serial Synchronous Interface (SSI)

SSI output provides effective synchronization in a closed-loop control system. A clock pulse train from a controller is used to clock out sensor data: one bit of position data is transmitted to the controller per one clock pulse received by the sensor. The use of a differential driver permits reliable transmission of data over long distances in environments that may be electrically noisy. The encoder utilizes a clock signal, provided by the user interface, to time the data transmission. Receiving electronics must include an appropriate receiver as well as line terminating resistors.

Features

- Synchronous transmission
- Transmission lengths to 1000 feet
- Accepts clock rates from 100 KHz to 1.8 MHz

Data Transmission Sequence

1. Output driver of the encoder is a MAX 491 transceiver in transmit mode. The recommended receiver is a MAX 491 transceiver in receive mode.
2. Controller provides a series of pulses (or differential pulse pairs) on the CLOCK input lines.
3. On the first HIGH-to-LOW CLOCK transition, the encoder latches its data at the current position and prepares to transmit.
4. Controller reads data on the falling edge of the next 16 clock cycles.
5. The first bit is a START bit and is always HIGH.
6. Next come 12 data bits beginning with the most significant bit (MSB) and ending with the least significant bit (LSB). This is followed by three LOW pulses.
7. After the DATA bits, the DATA line goes LOW and remains LOW for a minimum of 30 microseconds between the end of the DATA bits and the beginning of the next CLOCK series.

Interfacing Long Data Lines

Cable impedance can create a transmission delay, in effect, shifting the phase relationship between the clock pulse and the data. If this phase shift exceeds 180°, then the wrong bit position will be sampled by the receiver. As a result, the maximum allowable clock frequency is a function of the cable length. For 24 AWG, stranded, 3 pair cable (BEI part number 37048-003 or equivalent) the group delay is 1.36ns/ft. The table below shows the maximum transmission rate allowable as a function of cable length to ensure a phase shift of less than 90°.

CLOCK, Maximum (kHz) = 92,000 / Cable Length (ft)CW

Cable Length (ft)	50	100	200	300	500	1000
Max Freq (kHz)	1800	900	500	300	200	100

SSI Timing

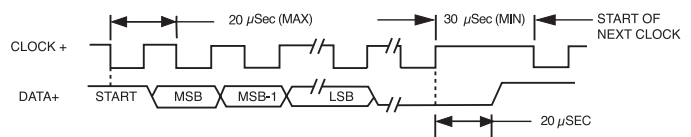

Ordering SSI

HOW TO SPECIFY SSI OUTPUT IN THE ENCODER MODEL NUMBER:

Use the designation, S3 between the **Code Format** designation and the **Connector** designation.

Example: H25D-SS-12GC-S3-CW-SM18



Single Turn Absolute Encoder Options

The tables below are reference for pinouts, connections and operation of BEI's single turn absolute encoders. These absolute options are available in a wide range of package styles with a variety of outputs. The applicability table below shows which combinations are currently available. As always, you can call us at **800-350-ASAP (2727)** for immediate applications assistance should you have any questions.

Output Code and Terminations (12 & 13 Bit)								
PARALLEL CODE					TERMINATION TYPE			
	Gray Code		Natural Binary		Binary Coded Decimal	Cable	Conn	Term Board H38 & H40
	12 Bit	13 Bit	12 Bit	13 Bit				
MSB	G ₁₁	G ₁₂	2 ¹¹	2 ¹²	A ₀	WHT/BLK	A	1
	G ₁₀	G ₁₁	2 ¹⁰	2 ¹¹	B ₀	WHT/BRN	B	2
	G ₉	G ₁₀	2 ⁹	2 ¹⁰	C ₀	WHT/RED	C	3
	G ₈	G ₉	2 ⁸	2 ⁹	D ₀	WHT/ORN	D	4
	G ₇	G ₈	2 ⁷	2 ⁸	A ₁	WHT/YEL	E	5
	G ₆	G ₇	2 ⁶	2 ⁷	B ₁	WHT/GRN	F	6
	G ₅	G ₆	2 ⁵	2 ⁶	C ₁	WHT/BLU	G	7
	G ₄	G ₅	2 ⁴	2 ⁵	D ₁	WHT/IO	H	8
	G ₃	G ₄	2 ³	2 ⁴	A ₂	WHT/GRY	J	9
	G ₂	G ₃	2 ²	2 ³	B ₂	WHT	K	10
	G ₁	G ₂	2 ¹	2 ²	C ₂	GRY/BLK	L	11
	LSB ₁₂	G ₀	G ₁	2 ⁰	2 ¹	D ₂	GRY/BRN	M
LSB ₁₃		G ₀		2 ⁰	A ₃	GRY/RED	N	13
	*0V (CIRCUIT COMMON)				B ₃	GRY/ORN	P	
	DIRECTION CONTROL					ORN	R	18
	CASE GROUND					GRN	S	16
	0 V (CIRCUIT COMMON)					BLK	T	15
	LATCH CONTROL					YEL	U	17
	+V (SUPPLY VOLTAGE)					RED	V	14
	SHIELD DRAIN					BARE	—	

*Pin P is available for a tri-state option

Output Applicability Table								
	12 BITS PARALLEL	13 BITS PARALLEL	14/15 BITS	12x12 BITS	SSI	RS422	4-20 mA	0-10 V
H25	•	•			•	•	•	•
H25X			•					
HS35	•				•			
H38	•	•		•	•	•	•	•
H40	•	•		•	•	•	•	•
HMT25				•	•			

Direction Control: Standard is CW increasing when viewed from the shaft end. Pin R is normally HI (or N/C) and is pulled up internally to +V. To reverse the count direction, Pin R must be pulled LO (COMMON).

Latch control: Encoder outputs are active and provide continuous parallel position information when Pin U is HI (or N/C). Pin U is pulled up internally to +V. When Pin U is LO (COMMON) the encoder outputs are latched at the logic state that is present when the latch is applied and will stay latched until Pin U is no longer grounded.

Dir/Latch on 15-Bit Encoders: Due to a limited number of connector pins, either direction control or latch is available on pin U.

Parallel Code (14 & 15 Bit)					
	Gray Code		Natural Binary		M14/19 Connector
	14 BIT	15 Bit	14 BIT	15 Bit	
LSB	G ₀	G ₀	2 ⁰	2 ⁰	A
	G ₁	G ₁	2 ¹	2 ¹	B
	G ₂	G ₂	2 ²	2 ²	C
	G ₃	G ₃	2 ³	2 ³	D
	G ₄	G ₄	2 ⁴	2 ⁴	E
	G ₅	G ₅	2 ⁵	2 ⁵	F
	G ₆	G ₆	2 ⁶	2 ⁶	G
	G ₇	G ₇	2 ⁷	2 ⁷	H
	G ₈	G ₈	2 ⁸	2 ⁸	J
	G ₉	G ₉	2 ⁹	2 ⁹	K
	G ₁₀	G ₁₀	2 ¹⁰	2 ¹⁰	L
	G ₁₁	G ₁₁	2 ¹¹	2 ¹¹	M
	G ₁₂	G ₁₂	2 ¹²	2 ¹²	N
MSB14	G ₁₃	G ₁₃	2 ¹³	2 ¹³	P
MSB15	DIR CONTROL	G ₁₄	DIR CONTROL	2 ¹⁴	R
	CASE GROUND	CASE GROUND	CASE GROUND	CASE GROUND	S
	CIRCUIT COMMON	CIRCUIT COMMON	CIRCUIT COMMON	CIRCUIT COMMON	T
	LATCH	DIR/LATCH	LATCH	DIR/LATCH	U
	+V SUPPLY VOLTAGE	+V SUPPLY VOLTAGE	+V SUPPLY VOLTAGE	+V SUPPLY VOLTAGE	V

SSI Output Termination Table					
	M18 CONN	M14/19 CONN	CABLE CONN	TERM. BOARD	
				H38	H40
DATA +	A	A	YEL	4	1
DATA-	H	B	WHT/YEL	7	7
CLOCK+	B	C	BLU	5	2
CLOCK-	I	D	WHT/BLU	8	8
DIR CONTROL	C	R	ORN	6	3
CASE GROUND	G	S	GRN	1	6
CIRCUIT COMMON	F	T	BLK	2	5
+V SUPPLY VOLTAGE	D	V	RED	3	4
SHIELD DRAIN	—	—	BARE	—	—

M18 Connector is a MS3102R18-1P, 10-pin connector on the encoder body and mates to an MS3106F18-1S connector or can be used with a standard cable/connector assembly, BEI P/N 924-31186-18XX (Where X = 10, 20 or 30 for a 10, 20, or 30 foot length). This is the preferred connector for SSI output.

M14/19 Connector is a MS3112E14-19P, 19-pin connector on the encoder body and mates to an MS3116F14-19S or equivalent.